

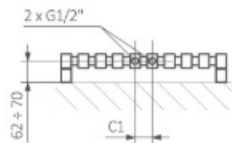

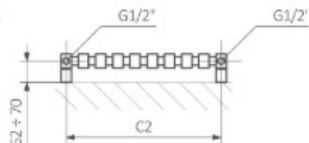
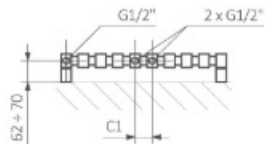
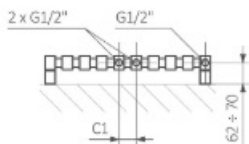
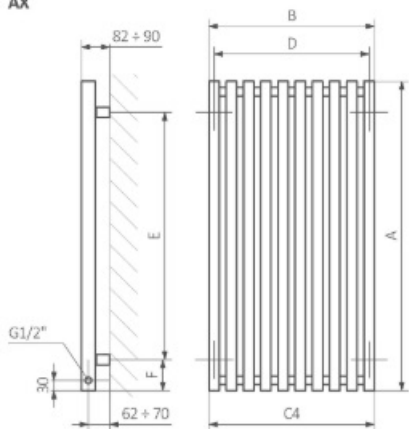
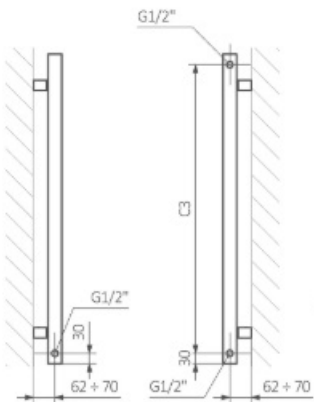
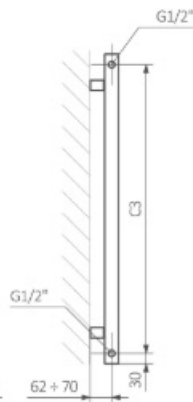

ZX**SX****Z1****Z8****AX****PX****LX**

A ↓ [mm]	B ↔ [mm]	C1 ↻ [mm]	C2 ↻ [mm]	C3 ↻ [mm]	C4 ↻ [mm]	C5 ↻ [mm]	75/65/20°C [W]	55/45/20°C [W]	 [W]	D [mm]	E [mm]	F [mm]	 [dm³]	 [kg]	Kód výrobku
paint															
560	480	50	450	500	480	500	356	192	400	450	380	90	5.72	10.14	WGTRG056048
560	680	50	650	500	680	500	504	272	600	650	380	90	8.01	14.25	WGTRG056068
560	880	50	850	500	880	500	652	352	600	850	380	90	10.31	18.36	WGTRG056088
560	1080	50	1050	500	1080	500	800	431	800	1050	380	90	12.60	22.47	WGTRG056108
560	1280	50	1250	500	1280	500	948	511	1000	1250	380	90	14.90	26.58	WGTRG056128
610	480	50	450	550	480	500	391	210	400	450	430	90	6.22	10.93	WGTRG061048
610	680	50	650	550	680	500	554	298	600	650	430	90	8.71	15.36	WGTRG061068
610	880	50	850	550	880	500	717	385	800	850	430	90	11.21	19.79	WGTRG061088
610	1080	50	1050	550	1080	500	880	473	800	1050	430	90	13.70	24.22	WGTRG061108
610	1280	50	1250	550	1280	500	1043	560	1000	1250	430	90	16.19	28.65	WGTRG061128
900	380	50	350	840	380	500	459	242	400	350	720	90	7.29	12.4	WGTRG090038
900	480	50	450	840	480	500	580	306	600	450	720	90	9.11	15.54	WGTRG090048
900	580	50	550	840	580	500	701	370	800	550	720	90	10.94	18.67	WGTRG090058
900	680	50	650	840	680	500	821	433	800	650	720	90	12.76	21.81	WGTRG090068
1300	380	50	350	1240	380	500	652	339	600	350	1120	90	10.48	17.48	WGTRG130038
1300	480	50	450	1240	480	500	824	429	800	450	1120	90	13.10	21.89	WGTRG130048
1300	580	50	550	1240	580	500	996	518	1000	550	1120	90	15.72	26.3	WGTRG130058
1300	680	50	650	1240	680	500	1168	608	1200	650	1120	90	18.34	30.7	WGTRG130068
1700	380	50	350	1640	380	500	850	437	800	350	1520	90	13.67	22.57	WGTRG170038
1700	480	50	450	1640	480	500	1074	552	1000	450	1520	90	17.09	28.24	WGTRG170048
1700	580	50	550	1640	580	500	1298	667	1200	550	1520	90	20.51	33.92	WGTRG170058
1700	680	50	650	1640	680	500	1521	781	1500	650	1520	90	23.93	39.6	WGTRG170068
1900	380	50	350	1840	380	500	962	492	1000	350	1720	90	15.26	25.11	WGTRG190038
1900	480	50	450	1840	480	500	1202	615	1200	450	1720	90	19.08	31.42	WGTRG190048
1900	580	50	550	1840	580	500	1442	737	1500	550	1720	90	22.90	37.73	WGTRG190058
1900	680	50	650	1840	680	500	1683	860	1500	650	1720	90	26.72	44.04	WGTRG190068

Triga



Barva je zahrnuta v ceně

Realizační lhůta: 23 dnů

Připojení:

Výška 560 mm±1900:



Výška 560 mm±610:



Výška [mm] 900±1900:



Elektrické radiátory – viz strana 114.

Výška [mm] 900±1900:



Výška 560 mm±610:



Doporučujeme:



Police TRIGA – masivní dřevo 680 mm
WRPTRG068 BUK: 75 EUR
WRPTRG068 DAB: 78 EUR
WRPTRG068 TEAK: 162 EUR
Příčky, vlnáky: viz s. 170.



Max. provozní tlak: 1000 kPa

Maximální provozní teplota: 95°C

Výška [mm]	Šíře [mm]	75/65/20°C [W]	55/45/20°C [W]	 [W]	Barvy RAL a speciální barvy Cena bez DPH [EUR]	Čtrnati	Kód výrobku	Kód konfg. info s. 232. ▶
560	480	356	192	400	364	-	WGTRG056048	VLOŽTE KÓD
560	680	504	272	600	440	-	WGTRG056068	VLOŽTE KÓD
560	880	652	352	600	516	-	WGTRG056088	VLOŽTE KÓD
560	1080	800	431	800	605	-	WGTRG056108	VLOŽTE KÓD
560	1280	948	511	1000	706	-	WGTRG056128	VLOŽTE KÓD
610	480	391	210	400	389	-	WGTRG061048	VLOŽTE KÓD
610	680	554	298	600	453	-	WGTRG061068	VLOŽTE KÓD
610	880	717	385	800	516	-	WGTRG061088	VLOŽTE KÓD
610	1080	880	473	800	643	-	WGTRG061108	VLOŽTE KÓD
610	1280	1043	560	1000	744	-	WGTRG061128	VLOŽTE KÓD
900	380	459	242	400	326	-	WGTRG090038	VLOŽTE KÓD
900	480	580	306	600	389	-	WGTRG090048	VLOŽTE KÓD
900	580	701	370	800	453	-	WGTRG090058	VLOŽTE KÓD
900	680	821	433	800	541	-	WGTRG090068	VLOŽTE KÓD
1300	380	652	339	600	402	-	WGTRG130038	VLOŽTE KÓD
1300	480	824	429	800	465	-	WGTRG130048	VLOŽTE KÓD
1300	580	996	518	1000	541	-	WGTRG130058	VLOŽTE KÓD
1300	680	1168	608	1200	605	-	WGTRG130068	VLOŽTE KÓD
1700	380	850	437	800	440	-	WGTRG170038	VLOŽTE KÓD
1700	480	1074	552	1000	503	-	WGTRG170048	VLOŽTE KÓD
1700	580	1298	667	1200	579	-	WGTRG170058	VLOŽTE KÓD
1700	680	1521	781	1500	668	-	WGTRG170068	VLOŽTE KÓD
1900	380	961	492	1000	478	-	WGTRG190038	VLOŽTE KÓD
1900	480	1202	615	1200	541	-	WGTRG190048	VLOŽTE KÓD
1900	580	1442	737	1500	630	-	WGTRG190058	VLOŽTE KÓD
1900	680	1682	860	1500	719	-	WGTRG190068	VLOŽTE KÓD

Barvy

Uvedené barvy se mohou mírně lišit od skutečných. Pro přesný výběr barev použijte originální vzorník, který je k dispozici u našich obchodních manažerů a prodejních partnerů.



VZORNÍK BAREV RAL (80% LESKU)

RAL: KÓD:	1000 100	1001 101	1002 102	1003 103	1004 104	1005 105	1006 106	1007 107	1011 111	1012 112	1013 113	1014 114
1015 115	1016 116	1017 117	1018 118	1019 119	1020 120	1021 121	1023 123	1024 124	1027 127	1028 128	1032 132	1033 133
1034 134	1037 137	2000 200	2001 201	2002 202	2003 203	2004 204	2008 208	2009 209	2010 210	2011 211	2012 212	3000 300
3001 301	3002 302	3003 303	3004 304	3005 305	3007 307	3009 309	3011 311	3012 312	3013 313	3014 314	3015 315	3016 316
3017 317	3018 318	3020 320	3022 322	3027 327	3028 328	3031 331	4001 401	4002 402	4003 403	4004 404	4005 405	4006 406
4007 407	4008 408	4009 409	4010 410	5000 500	5001 501	5002 502	5003 503	5004 504	5005 505	5007 507	5008 508	5009 509
5010 510	5011 511	5012 512	5013 513	5014 514	5015 515	5017 517	5018 518	5019 519	5020 520	5021 521	5022 522	5023 523
5024 524	6000 600	6001 601	6002 602	6003 603	6004 604	6005 605	6006 606	6007 607	6008 608	6009 609	6010 610	6011 611
6012 612	6013 613	6014 614	6015 615	6016 616	6017 617	6018 618	6019 619	6020 620	6021 621	6022 622	6024 624	6025 625
6026 626	6027 627	6028 628	6029 629	6032 632	6033 633	6034 634	7000 700	7001 701	7002 702	7003 703	7004 704	7005 705
7006 706	7008 708	7009 709	7010 710	7011 711	7012 712	7013 713	7015 715	7016 716	7021 721	7022 722	7023 723	7024 724
7026 726	7030 730	7031 731	7032 732	7033 733	7034 734	7035 735	7036 736	7037 737	7038 738	7039 739	7040 740	7042 742
7043 743	7044 744	7045 745	7046 746	7047 747	8000 800	8001 801	8002 802	8003 803	8004 804	8007 807	8008 808	8011 811
8012 812	8014 814	8015 815	8016 816	8017 817	8019 819	8022 822	8023 823	8024 824	8025 825	8028 828	9001 901	9002 902
9003 903	9004 904	9006 906	9007 907	9010 910	9011 911	9016 916	9017 917	9018 918				

Některé TERMA barvy RAL jsou na následujících 2 stranách označeny jako MATT (polomat) nebo SOFT (mat) a lze je objednat přímo jako polomatné nebo matné. Všechny ostatní barvy RAL si můžete také objednat jako MATT (50% lesku), nebo SOFT (20-30% lesku) s příplatkem 25%, neboť mají jednu zmatňující vrstvu navíc.

VZORNÍK SPECIÁLNÍCH BAREV

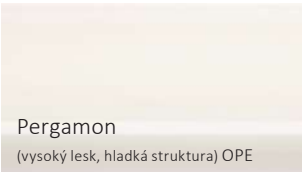
Název:	Heban (matná metalíza, hrubá struktura)	Black Pepper (matná, hrubá 3D struktura)	Metallic Black (matná metalíza, hrubá struktura)
KÓD:	IHE	CPE	MBC
Black Crocodile New (matná, hrubá 3D struktura) BLN	Soft 9005 (matná, hladká struktura) S95	Matt 9005 (polomat, hladká struktura) 9M5	Gloss 9005 (vysoký lesk, hladká struktura) 9P5
Anodic Black (metalíza, hladká struktura) ABC	Magic Pearl (vysoký lesk, hladká struktura) MPR	Sparkling Grey (vysoký lesk, hladká struktura) RGY	Metallic Grey (matná, hrubá struktura) MGR
Granite (vysoký lesk, hladká struktura) GRA	Modern Grey (matná, hrubá struktura) DGR	Storm Sky (matná, hladká struktura) SSK	Winter Sky (pololesk, hladká struktura) WSK
Graphite (matná metalíza, hrubá struktura) GRP	Salt & Pepper (matná, hrubá struktura) SPP	Inox (metalíza, hladká struktura) INO	Diamond Silver (lesklá metalíza, hladká struktura) DIS
Silver Gloss (vysoký lesk, hladká struktura) SPO	Silver Matt (pololesk, hladká struktura) SMA	Metallic Silver (metalíza, hrubá struktura) MSI	Vibrant Brown (metalíza, hrubá struktura) OVb
Metallic Stone (metalíza, hrubá struktura) MST	Sparkling Gravel (metalíza, hladká struktura) RGR	Quartz (matná metalíza, hrubá struktura) QUA	Metallic Beige (metalíza, hrubá struktura) MBE
Anodic Brown (metalíza, hladká struktura) ABN	African Bronze (metalíza, hladká struktura) IAZ	Noble Brown (matná metalíza, hrubá struktura) INB	Antique Copper (křídavková, lesklá 3D struktura) AMI
Copper (měděná metalíza, hladká) COP	Bright Copper (měděná metalíza, hladká) BCO	Van Gogh (metalíza, hrubá 3D struktura) IVG	Gold Gloss (zlatá metalíza, hladká) GPO

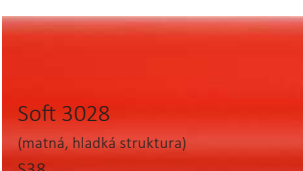
 <p>California Beige (matná metalíza, hrubá struktura) ICB</p>	 <p>Morning Beige (vysoký lesk, hladká struktura) BTS</p>	 <p>Sparkling Cream (matná, hrubá struktura) RCR</p>	 <p>Blush (matná, hrubá struktura) BUH</p>
 <p>Modern Ivory (pololesk, hrubá struktura) DIV</p>	 <p>White Gold (kladivková, lesklá 3D struktura) WGD</p>	 <p>Pergamon (vysoký lesk, hladká struktura) OPE</p>	 <p>Sea Salt (perleťová metalíza, hrubá struktura) FMS</p>
 <p>Sweet Sugar (vysoký lesk, hladká struktura) FSS</p>	 <p>White Cream (pololesk, hladká struktura) WCR</p>	 <p>Soft 9016 (matná, hladká struktura) S96</p>	 <p>White Wall (perleťová metalíza, hrubá struktura) WWL</p>
 <p>Blueberry (matná metalíza, hladká struktura) BLR</p>	 <p>Anodic Sapphire (matná metalíza, hladká struktura) ASP</p>	 <p>Anodic Malachite (matná metalíza, hladká struktura) AMT</p>	 <p>Pastel Blue (matná metalíza, hladká struktura) PBL</p>
 <p>Soft 7047 (matná, hladká struktura) S77</p>	 <p>Lavender (metalíza, hladká struktura) LAV</p>	 <p>Soft 4010 (matná, hladká struktura) S40</p>	 <p>Soft 4006 (matná, hladká struktura) S46</p>
 <p>Soft 3028 (matná, hladká struktura) S38</p>	 <p>Metallic Red (matná metalíza, hrubá struktura) MRE</p>	 <p>Soft Green Apple (matná, hladká struktura) SGA</p>	 <p>Soft 1023 (matná, hladká struktura) S13</p>
 <p>Chrome Effect (imitace chromu, vysoký lesk) CRE</p>			

Galvanická povrchová úprava

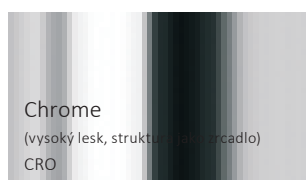

Raw Copper



Barevná varianta dostupná pouze pro Pajak a Pajak E.
Vzhledem ke svým vlastnostem může povrch časem změnit barvu, ztmavnout.